

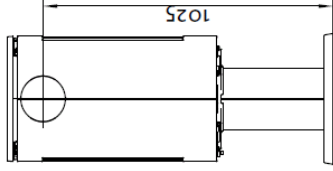

Product:  
 Jøtul F 371 / F 373 / F 374 / F 375 / F 376 / F 377 / F 379 / F 370 C

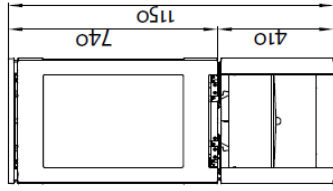

Base model:

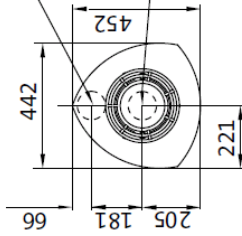

Hole in floor for outside air  
 Ø100mm connection  
 Jøtul F 371, F 374, F 375, F 376,  
 F 377, F 379

Hole in floor for outside air  
 Ø100mm connection  
 Jøtul F 373

Jøtul F 377:

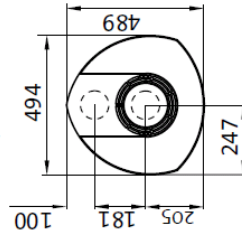

Jøtul F 370 C:

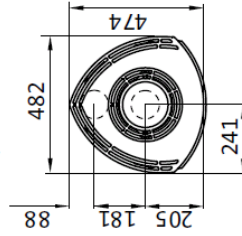

Min. measure floorplate  
 X/Y = Acc. to national standards  
 and regulations.

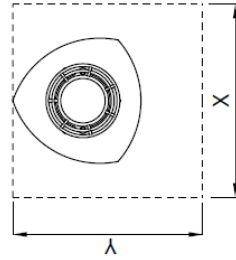

Min. distance to combustible wall:  
 See table above.

Combustible wall

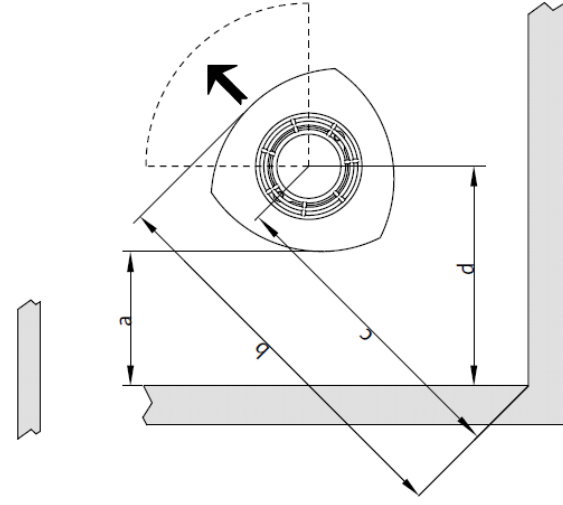

Distance to combustible wall with revolvable pedestal:  
 See table above.

